

S-type

Active Sealing Wire Tensioning System: **ASWT** System

A specially developed sealing wire tensioning system ensures that the sealing wires are constantly tensioned at any sealing temperature at the right level. This ensures extreme wear resistance for the sealing wire and PTFE coating (wear parts) and further a smooth, beautiful sealing.

HIGH QUALITY SEALING

Sealing temperature 80–220 °C

Time controlled sealing and cooling

hacona.com Go online, get closer and be inspired

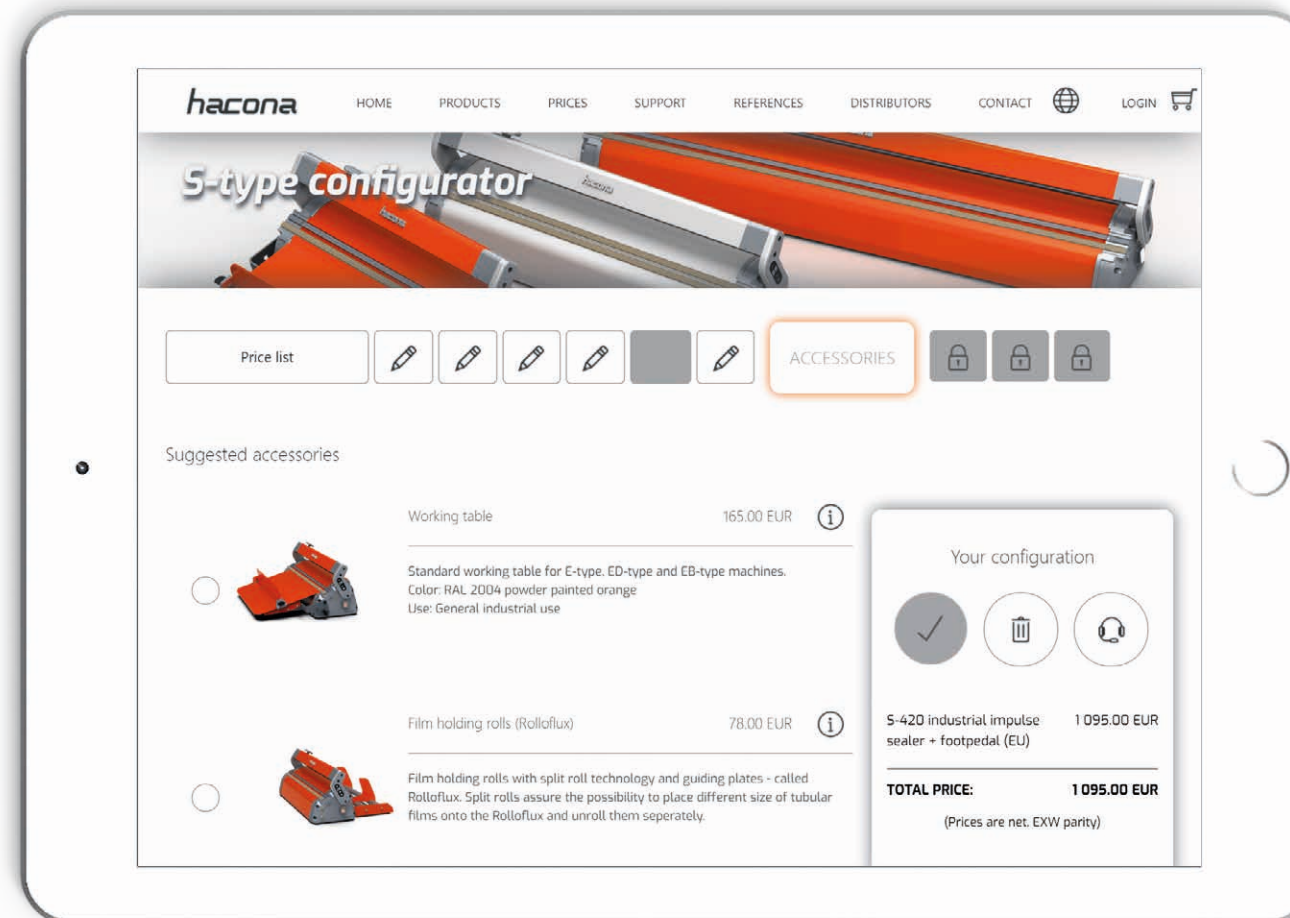

Technical data	S		SD		SB		S	
	320	420	620	820	1020			
Max. sealing length [mm]	320	420	620	820	1020			
Sealing width [mm]	5	5	2 x 5	5	2 x 5	5	5	
Max. sealable film width [mm]	310	410	610	810	1010			
Max. cutting width [mm]	310	410	610	810	1010			
IP protection class [IP]	IP 23							
Electrical connection [V, Hz]	230, 50/60							
Max. power consumption* [W]	500	450	650	350	500	500	1000	
Dimension (LxWxH), sealer [mm]	505 x 206 x 255	605 x 206 x 255	805 x 206 x 255	1005 x 206 x 255	1205 x 206 x 255			
Dimension (LxWxH), complete** [mm]	525 x 553 x 1085	625 x 553 x 1085	825 x 553 x 1085	1025 x 553 x 1085	1225 x 553 x 1085			
Weight, sealer [kg]	11.70	13.20	15.20	16.50	18.50	18.50	23.20	
Weight, complete** [kg]	23.60	26.20	28.20	31.50	33.50	33.50	40.10	

* while sealing (In standby mode, power consumes is 20 W for all types)
** includes stand, foot pedal and working table

Electrical plug: EU plug standard; UK and USA plug as option available
Power supply [V/Hz]: 230 V 50/60 Hz standard; 110 V 50 Hz as option available

Details provided relating to the properties and use of the products are purely for information purposes and do not constitute a guarantee of these characteristics. The extent of goods delivered is determined by the subject matter of the specific contract. No liability accepted for errors or omissions. Subject to technical alterations.

Production and headquarter:

Hacona Packaging Technology Kft.
Bokenyfoldi ut 106.,
1165 Budapest – Hungary

Tel.: +36 1 401 3030
Fax: +36 1 401 3031
E-mail: mail@hacona.com
Web: www.hacona.com

Dealer:

hacona®



S-type

Semi-automatic impulse sealers
Premium Quality. Flexibility. Modular System.

DEDICATED TO WORK



STAINLESS
for Food, Pharma,
Chemical

SURFACE FINISH

- Orange painted – general industry
Model: S-type
- INOX – food/pharmaceutical industry
Model: SI-type

SUITABLE FOR SEALING

- PE (LDPE, HDPE)
- PP, PA
- PVC
- BOPP
- and any other laminated films that have a thermoplastic film inside

WORKING TABLE

- Supports ergonomic work
- Adjustable in 8 angles
- With adjustable bag support



hacona®

Well-known working performance

A range of semi-automatic sealing machines that can be used to securely seal filled bags or produce bags from roll material, suitable for sealing PE, PP, PVC, or any other laminated film with sealable inside layer.

Reliable efficient technology: ICS

IMPULSE CONTROLLED SEALING

Assures high working safety and the sealing wire gets hot ONLY when the sealing bars are closed and in sealing cycle. This provides a high level of safety at work and offers an environmentally friendly – energy saving – solution.

MACHINE FUNCTIONS

S-type 5 mm sealing (up to 500µm)

SD-type 2 x 5 mm sealing (up to 500µm)

- suggested for sealing dusty or contaminated bags
- two parallel sealings next to each other

SB-type Bi-Active 5 mm sealing (up to 800µm)

- suggested for sealing very thick bags
- sealing from two sides (upper and lower sealing)



S-type



SEALING HEIGHT
adjustment approx.
390-910 mm



IMPULSE
controlled
sealing



MODULAR
build-up

BASIC FEATURES OF S RANGE SEALERS

- Manufactured in five sealing widths - 320, 420, 620, 820 and 1020 mm.
- Easy to operate in a variety of applications.
- Electrically controlled and independently adjustable sealing and cooling times.
- Integral sealing wire tensioning system for perfect sealing result.
- Integral safety film cutter.
- Designed to seal filled bags and produce bags from rolls.

ACCESSORIES

- Support with foot pedal and film roll holder
- Working table with Standard Bag Support
- Aluminium table arm for pack weights above 5 kg
- Mobile Film Roll Holder with split roll function
- Mobile Foot Pedal with flexible connector cable
- Security Coding - Individual text (3mm height)
- Sealing wire with integrated cutting wire

SEALING & CUTTING EXPLANATION (all sizes in mm)

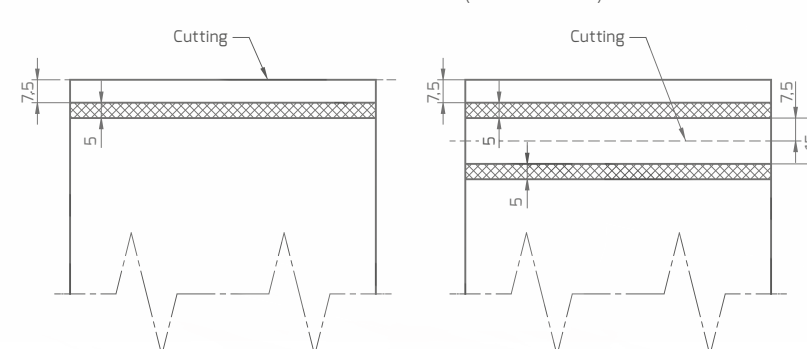

⊗ Single sealing
Model: S-type / SI-type

⊗⊗ Double sealing
Model: SD-type / SID-type

⊗⊗ Bi-active sealing
Model: SB-type / SIB-type

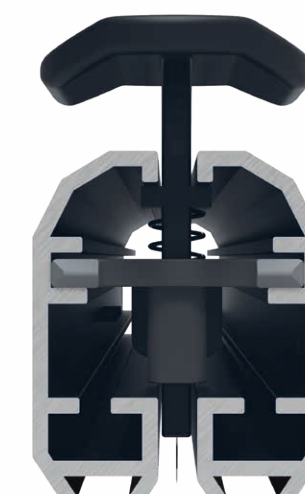

SAFETY CUTTING KNIFE SYSTEM

- Solid built up
- Changeable cutting blade
- Dual edged blade

Sealing sample

