



# SR20

Automation Grade	<b>SEMI</b>	Fully	Use Intensity	Low	<b>MEDIUM</b>	High
Format Setting	Manual	<b>AUTOMATIC</b>	Box Dimension	Small	<b>MEDIUM</b>	Large

## DATASHEET

SAFE • SUSTAINABLE • STRONG

## Semi-Automatic Case Sealer

The **SR20** is a semi-automatic case sealing machine designed and engineered by SIAT specifically for medium random sized boxes. SR20 is the ideal case sealing machine for a variety of industries like E-commerce, Logistics, Electronics and Tissue.

### KEY FEATURES

- ✓ **Practical** - Seals upper & lower flaps of cardboard cases or cartons
- ✓ **Added Protection** - Lockable electric isolation switch
- ✓ **Taping Heads** - Available with K11 or K12 taping heads
- ✓ **Faster** - 30 m/min belt conveyor speed option available
- ✓ **Ecological** - Energy saving option available
- ✓ **Light & Robust** – Columns made of aluminium
- ✓ **Quality Build** - Best-In-Class components with SIEMENS electrics and FESTO pneumatic components
- ✓ **Powerful** – Motorization 2x 130 Watt
- ✓ **Practical Design** - Quick release Taping Heads (Top & Bottom – No tools required)
- ✓ **CE compliant** - Engineered and produced in Italy according to EU safety standards

### MACHINE DIMENSIONS

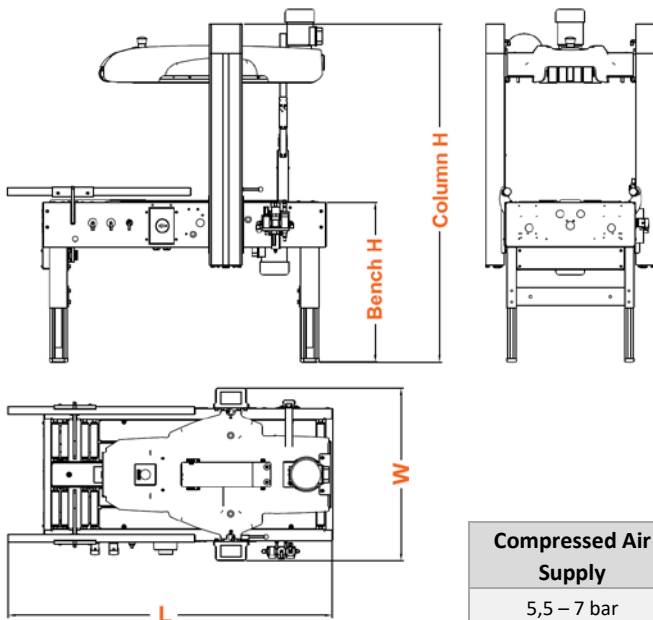

Compressed Air Supply	
5,5 – 7 bar	
NL/Cycle	7

Machine Dimensions		
	Min (mm)	Max (mm)
H Column	1.270	1.610
H Bench	485	825
W	740	740
W Bench	570	570
L	1.394	1.394

Standard Power Supply	
380/400V - 50Hz - 3ph	
440V - 60Hz - 3ph	
Amps	1,08
Power kW	0,26
Phase	3Ph +N + PE



# SR20



## DATASHEET

### Technical Data

Belt position	Top + Bottom
Box Size	Medium
Min / Max box weight	0.5 - 32 kg
Default Taping Head	K11 for 2" = 50 mm
Alternative Taping Heads	K12 for 3" = 75 mm
Power Consumption (std.)	0,26 kw
Air Consumption (NL/Cycle)	7
Operator Side	Left (std.) / Right
Tape width (mm)	50 (std.) / 75
Tape Leg (mm)	70 (std.) / 50 / 30
Ingress Protection Code	IP54
Ambient Operating Temperature	+5° / +40° C
Maximum level of noise	Depending on tape quality

### Features

Removable Top Taping-Head	•
Removable Bottom Taping-Head	•
Adjustable Tape Leg	•
Pre-Installed & Easy-To-Mount	•
Adjustable Tape Contact Pressure	•
Autom. Box Format Setting	•
Flap Folding Function	-
Belt Speed Selection	-
Fully Automatic Operation	-
SIAT Taping-Logic on board	-

### MORE MACHINE DIMENSIONS

Length x Width	1.394 x 740
Workbench Width	570
Height H (std. legs)	1.270 – 1.610
Height H1 (std. legs + wheels AS77)	1.380 – 1.720
Height H2 (opt. legs AS80)	1.430 – 1.765
Height H3 (opt. legs AS80 + wheels AS77)	1.540 – 1.875
Workbench Height Z (std. legs)	485 – 825
Workbench Height Z1 (std. legs + wheels AS77)	595 – 935
Workbench Height Z2 (opt. legs AS80)	645 – 980
Workbench Height Z3 (opt. legs AS80 + wheels AS77)	755 – 1.090

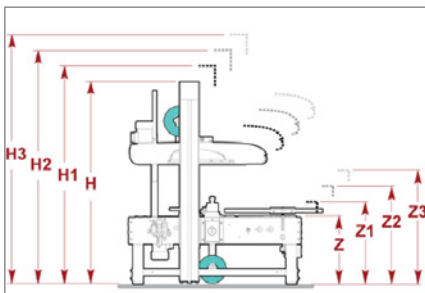

### SPECIAL VERSIONS

Special Versions according to individual application and safety requirements are possible on request.

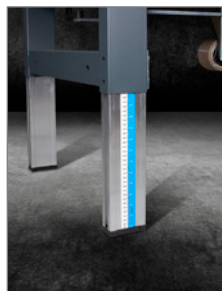
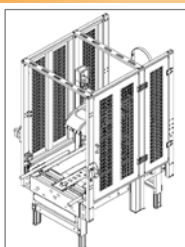

### BOX DIMENSIONS & PRODUCTIVITY

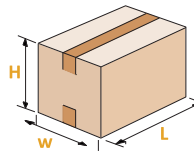

\*140 mm with 50 mm taping head K11  
170 mm with 75 mm taping head K12

Box Dimensions	L (mm)	W (mm)	H (mm)
Min.	150	140*	100**
Max.	∞	500	500

\*\*100 mm high box manageable with 50 mm tape leg  
120 mm high box manageable with 70 mm tape leg

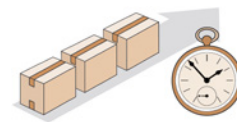

Max. production capacity:  
**Up to 900\* BPH**

\*Based on the shortest processible box length and provided an optimum continuous box infeed by the operator.

### PROCESSABLE TAPES

Base Material	PVC / OPP / PET / Paper*
Adhesive Type	Solvent / Hot Melt / Acrylic
Special Tape	Filament-Tape** / Safety-Seal-Tape***

\*with limitations \*\*special tape cutting blade required \*\*\*need of a test might be necessary

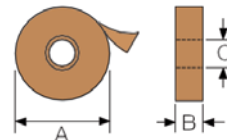

K11R / K12R	
A	Max. 410 mm
B	50 / 75 mm
C	76 mm

### BOX REQUIREMENTS

Quality result of the taped box depends on the general box quality and dimensional accuracy, as well as the quality of tape used.

Box Types: FEFCO 0201 – RSC  
*[other types may be possible as well]*

Adverse Impact Factors	Underfilling	Overfilling	Weak Boxes

### OPTIONS & ACCESSORIES

- Operation side "Right" (std. "Left")
- Special cutting blades filament-tape
- Taping Head for 75mm width
- Power Supply 220/230V – 50hz – 1ph
- Higher Legs
- Casters / Wheels
- Fix / Extendable Roller Conveyors
- Safety fences
- 30 m/min belt speed (std. 22)
- Energy Saving Kit
- End/Break Tape Device

### MORE DETAILS

Videos and further information can be found on our website or SIAT Youtube channel.



SAFE • SUSTAINABLE • STRONG

SIAT.com